





**DongGuan City Cled Optoelectronic Co.Ltd****Address:**2/F,No.1 Building,National High--tech Industrial Development**Tel:**0086-769- 23076887 **Fax:**0086-769- 23076156 **Email:** sales@bestcled.com**Issued by:**BESTCLED**Web:** www.bestcled.com**LED Street Light--160w**

| <b>Parameter</b>                                 |  |
|--|--|
| Code   | L-02   |
| Model  | CLED-LLD160-AC/220-G-S-III-C-L02   |
| Light efficiency                                 | ≥ 85 lm/W  |
| Life-span  | > 50000Hrs   |
| luminance decrease (3,000hrs)                    | ≤3%  |
| luminance decrease 6,000hrs                      | ≤6%  |
| luminance decrease 10,000hrs                     | ≤10%   |
| Color-renderingindex (CRI)                       | Ra > 80  |
| Power factor(PF)                                 | ≥0.95  |
| Chip of light source                             | U.S. (BRIDGELUX) Puri45*45mil BXCA4545XXX-D  |
| Material   | Aluminum alloy   |
| LED luminous efficiency                          | ≥ 100LM  |
| LED luminous flux                                | 16000LM  |
| Color temperature                                | 3500-6500K   |
| Luminous color                                   | Warm   |
| Frequency  | 50/60HZ  |
| Input Voltage                                    | AC 170V~265V   |
| Power factor(PF)                                 | >95%   |
| LED power consumption                            | 160W   |
| Whole lamp consumption                           | 173W   |
| The equal of sodium lamp                         | 400W   |
| Uniformity of illuminance                        | ≥ 0.6  |
| Juntion temperature                              | < 80℃  |
| IP grade   | IP65   |
| Working condition                                | Temprature: -30℃~50℃; Humidity:10%~90%RH   |
| Storage temperature                              | -10℃~60℃   |
| Application                                      | Secondary main road、Street、Bridge、Tunnel、Square、Cell   |
| Pole height                                      | 10-12m   |
| Environment protecting                           | No Mercury pollution and UV radiation,Ture green light   |
| Low heat   | Can be use for long time, reliable   |
| Stability  | Can be usd in wide range of voltage and temperature  |
| Anti-electric grade                              | III  |
| Standard of Electromagnetic Compatibility        | CISPR15/EN 55015   |
| Control methods                                  | Intemational standard DM×512control system   |
| EMC  | Good features EMI Meet the global targets  |
| Certificatons                                    |      |
| driveway width                                   | Two-way ,Eight-- lane  |
| Vertical center of the ground illumination lamps | > 30LUX  |
| Flare limitation                                 | cut-off G=7  |

**DongGuan City Cled Optoelectronic Co.Ltd**

**Address:**2/F,No.1 Building,National High--tech Industrial Development

**Tel:**0086-769- 23076887 **Fax:**0086-769- 23076156 **Email:** sales@bestcled.com

**Issued by:**BESTCLED

**Web:** www.bestcled.com

|                                      |  |
|--------------------------------------|--|
| Penetrability                        | Excellent penetrating fog  |
| Spacing for each two lights          | 30-45m   |
| Protecting time for short circuit    | ≤ 1S   |
| Heat emission and light distribution | Excellent speeding heat pipe make sure our light have a long life-span<br>Features that free-maintenance,solve the problem of luminous<br>Make use of our dependent intellectual property right to fulfill your requirement of lighting distribution curve |

**Photo**

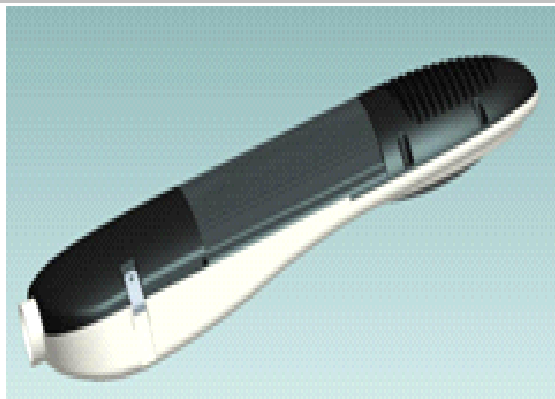

**Lighting distribution curve**

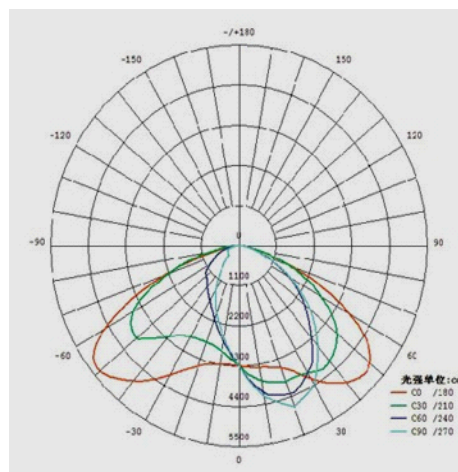

**Product size**

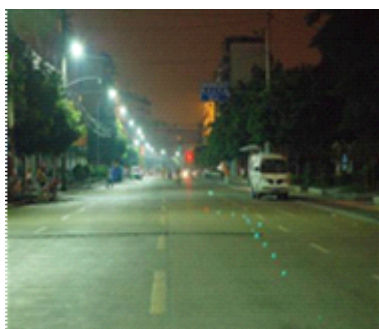
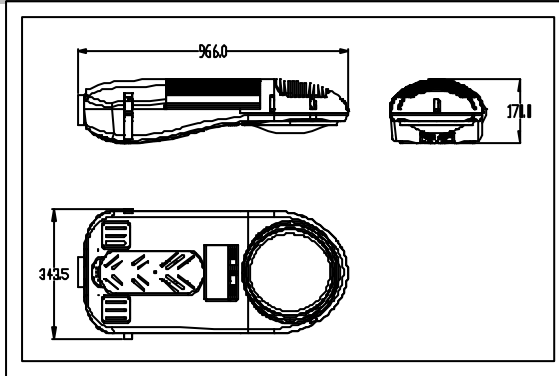

**DongGuan City Cled Optoelectronic Co.Ltd**

**Address:**2/F,No.1 Building,National High--tech Industrial Development

**Tel:**0086-769- 23076887 **Fax:**0086-769- 23076156 **Email:** sales@bestcled.com

**Issued by:**BESTCLED

**Web:** www.bestcled.com

