





DongGuan City Cled Optoelectronic Co.Ltd**Address:**2/F,No.1 Building,National High--tech Industrial Development**Tel:**0086-769- 2307 6887 **Fax:**0086-769- 2307 6156 **Email:** sales@bestcled.com**Issued by:**BESTCLED**Web:** www.bestcled.com**Street light—60W Solar Energy supply**

Parameter	
Code	T-A-04
Model	CLED-LLD60-DC/24-G-J- II -C-A02
Light efficiency	≧ 85 lm/W
Life-span	> 50,000Hrs
luminance decrease (3,000hrs)	≤3%
luminance decrease 6,000hrs	≤6%
luminance decrease 10,000hrs	≤10%
Color-renderingindex (CRI)	Ra > 80
Power factor(PF)	≧0.95
Chip of light source	U.S. (BRIDGELUX) Puri45*45mil BXCA4545XXX-D
Materia	Aluminum alloy
LED luminous efficiency	≧ 100LM
LED luminous flux	6000LM
Color temperature	3500-6500K
Luminous color	Warm
Frequency	50/60HZ
Input Voltage	DC 20V~26V
Power factor(PF)	>95%
LED power consumption	60W
Whole lamp consumption	66W
The equal of sodium lamp	200W
Uniformity of illuminance	≧0.6
Juntion temperature	< 80℃
IP grade	IP65
Working condition	Temprature: -30℃~50℃; Humidity:10%~90%RH
Storage temperature	-10℃~60℃
Application	Secondary main road、Street、Bridge、 Tunnel、 Square、 Cell
Pole height	8-10m
Environment protecting	No Mercury pollution and UV radiation,Ture green light
Low heat	Can be use for long time, reliable
Stability	Can be usd in wide range of voltage and temperature
Anti-electric grade	III
Standard of Electromagnetic Compatibility	CISPR15/EN 55015
Control methods	International standard DM×512control system
EMC	Good features EMI Meet the global targets
Certificatons	    

DongGuan City Cled Optoelectronic Co.Ltd

Address:2/F,No.1 Building,National High--tech Industrial Development

Tel:0086-769- 2307 6887 **Fax:**0086-769- 2307 6156 **Email:** sales@bestcled.com

Issued by:BESTCLED

Web: www.bestcled.com

driveway width	Two-way ,Four- lane
Vertical center of the ground illumination lamps	>14LUX
Flare limitation	cut-off G=7
Penetrability	Excellent penetrating fog
Spacing for each two lights	20-25m
Protecting time for short circuit	≤1S
Heat emission and light distribution	Excellent speeding heat pipe make sure our light have a long life-span Features that free-maintenance,solve the problem of luminous Make use of our dependent intellectual property right to fulfill your requirement of lighting distribution curve
Photo	CLED-LLD60-DC/24-G-J- II -C-A02

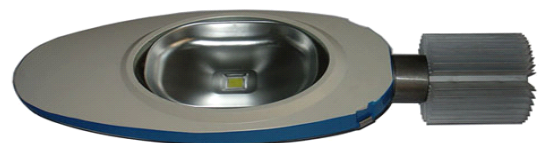
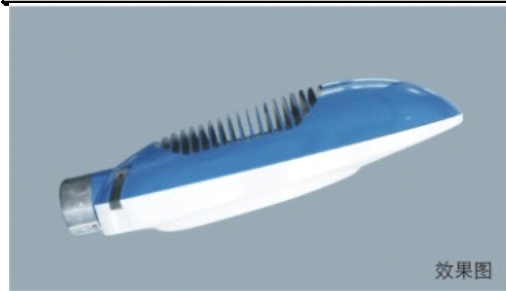

Lighting distribution curve	Product size
------------------------------------	---------------------

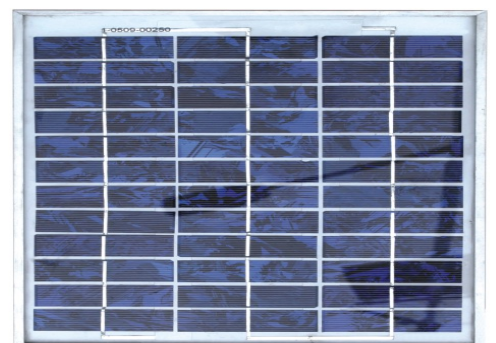
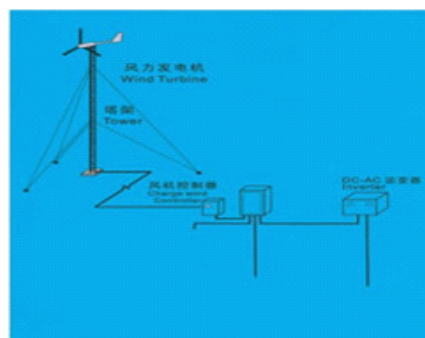
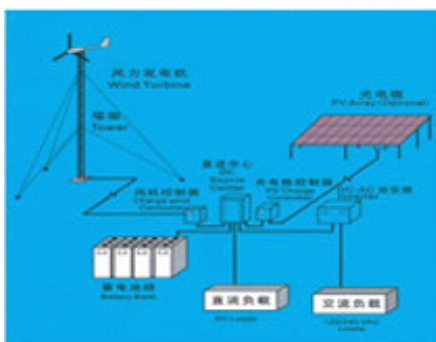
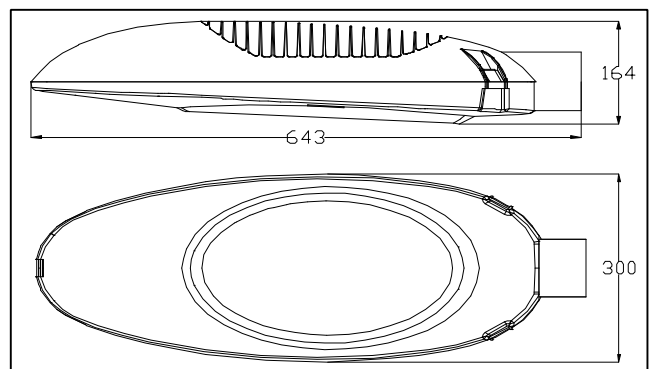
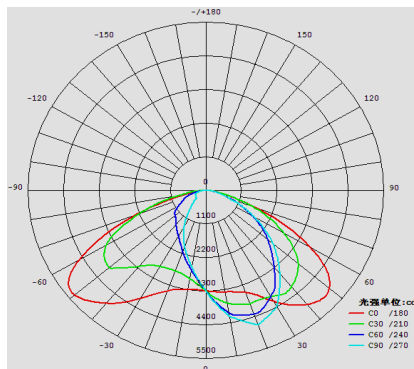

DongGuan City Cled Optoelectronic Co.Ltd

Address:2/F,No.1 Building,National High--tech Industrial Development

Tel:0086-769- 2307 6887 **Fax:**0086-769- 2307 6156 **Email:** sales@bestcled.com

Issued by:BESTCLED

Web: www.bestcled.com

Solar-wind system components

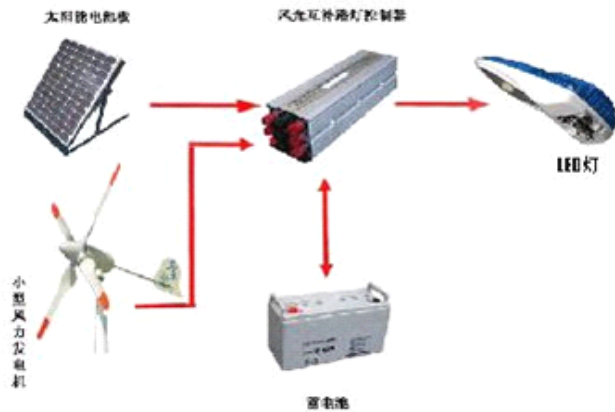
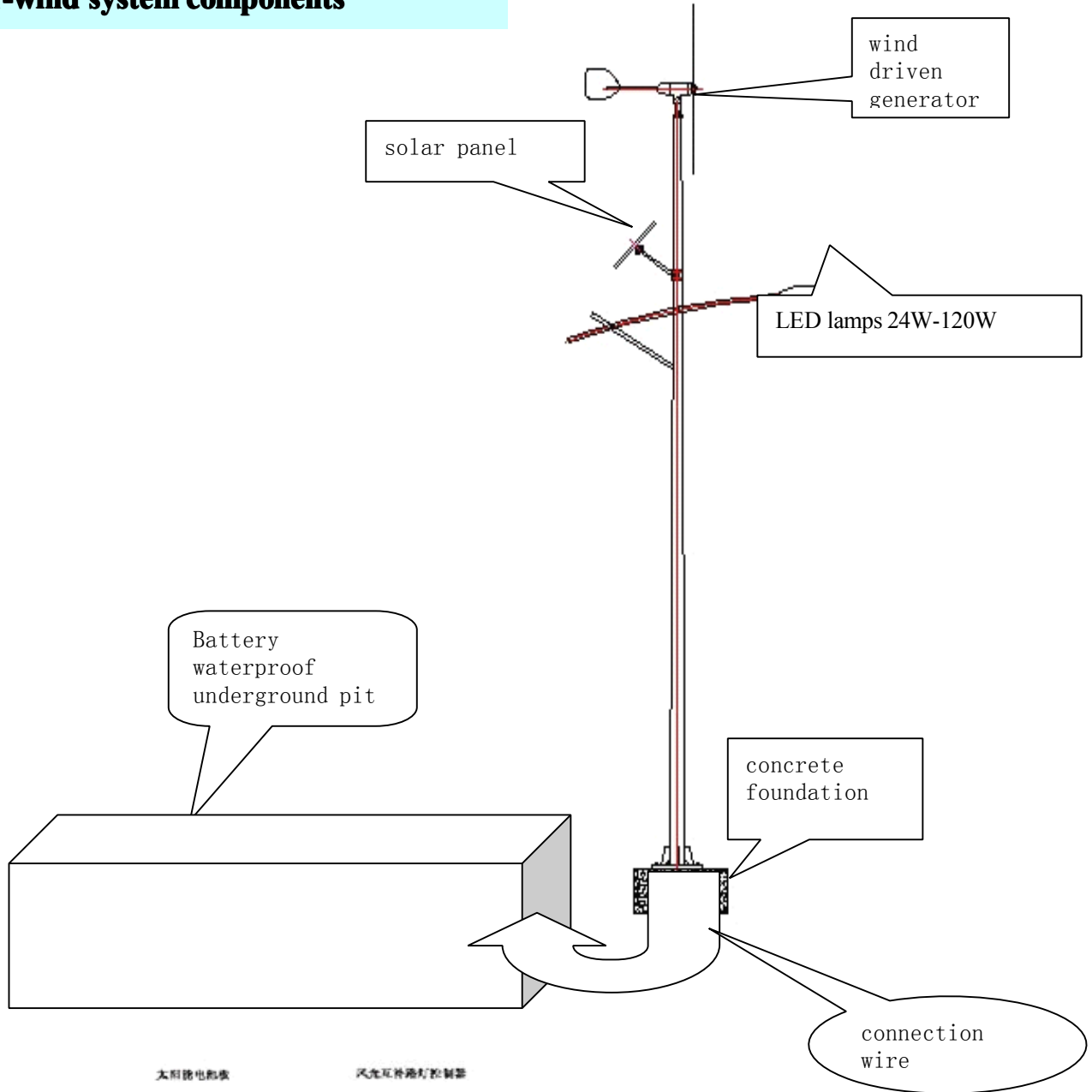

DongGuan City Cled Optoelectronic Co.Ltd

Address:2/F,No.1 Building,National High--tech Industrial Development

Tel:0086-769- 2307 6887 **Fax:**0086-769- 2307 6156 **Email:** sales@bestcled.com

Issued by:BESTCLED

Web: www.bestcled.com

